

PM-CAR1015

For immunotherapy discovery

Ready-to-Use CAR-T Cells and Target Cell Lines

Promab Biotechnologies' CAR-T new product development programs are being designed for pre-clinical and future clinical applications. CAR-T cells can be used for:

1. Compound screening
2. Antibody screening
3. Co-stimulatory and activation domain comparison
4. Personalized medicine and donor variations for CAR-T screening
5. Checkpoint inhibitors
6. Safety switches and regulators of CAR-T functions
7. Pre-clinical *in vivo* models
8. Treg and T memory cells in CAR-T setting
9. CAR-T signaling, tumor microenvironment
10. Proof of concept studies for clinical trials

The structure of CAR from Promab's available CAR-T cells targeting Mesothelin antigen

Mesothelin is a protein present on normal mesothelial cells and is overexpressed in several human tumors, including mesothelioma, ovarian and pancreatic adenocarcinoma. Mesothelin can be used as a tumor antigen for targeting by CAR-T immunotherapy.

Mesothelin CAR constructs

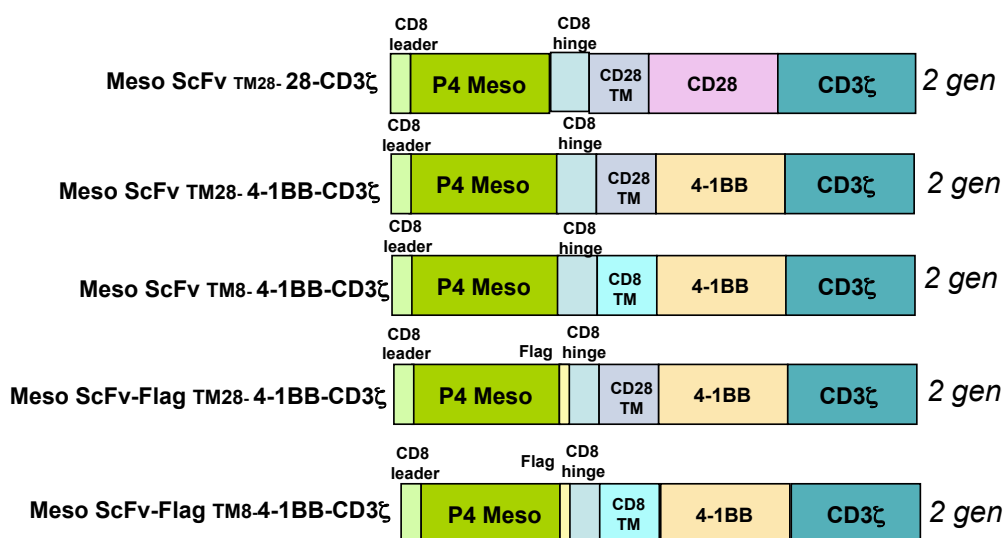

Figure 1. CAR-T cells expressing the above constructs are available from Promab targeting Mesothelin antigen. ScFv, single chain variable fragment.



PM-CAR1015

To date Promab generated 2nd or 3rd generation CAR and CAR controls (2nd generation of CAR is shown in Figure 1), CAR-T cells and CAR-Natural Killer (NK) effector cells against cancer target cells that show excellent functionality, including dose-dependent and target cell-specific cytotoxic activity (Figure 2).

These cells can be tested with CAR-T in cytotoxic assays and used for testing modulators of immune checkpoint inhibitors (PD-1, CTLA-4 pathways) or activators of immune response, small molecules affecting T cell or Treg activity.

Mesothelin-Positive Target Cells

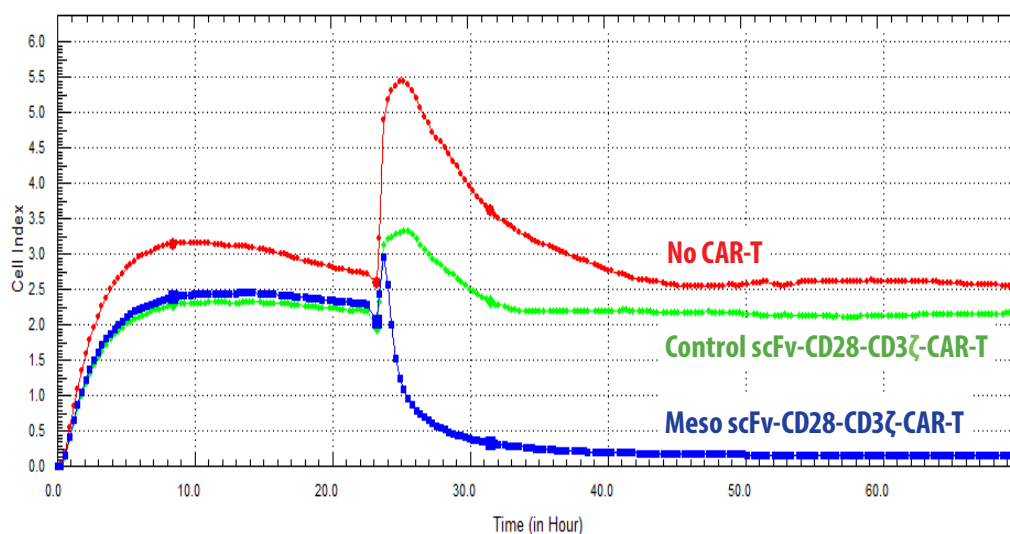

Figure 2. Real-time cytotoxic activity of Meso ScFv-CAR-T effector cells against Mesothelin-positive target cells. The ratio of effector cells to target cells is 10:1.

